

A quick
introduction
to dessins
d'enfants,
Belyi's
theorem and
Galois action

Ernesto
Girondo
Gabino
González-Diez

Dessins
PART I: From
dessins to
Belyi pairs
Examples
PART II:
Belyi's
theorem
Galois action
Action of
 $Gal(\overline{\mathbb{Q}})$ on
triangle curves

A quick introduction to dessins d'enfants, Belyi's theorem and Galois action

Ernesto Girondo
Gabino González-Diez

Universidad Autónoma de Madrid
Madrid, Spain

BIRS, September 2017.

Definition of dessin d'enfant (Grothendieck, 80's)

A quick introduction to dessins d'enfants, Belyi's theorem and Galois action

Ernesto Gironde Gabino González-Diez

Dessins

PART I: From dessins to Belyi pairs

Examples

PART II: Belyi's theorem

Galois action

Action of $Gal(\overline{\mathbb{Q}})$ on triangle curves

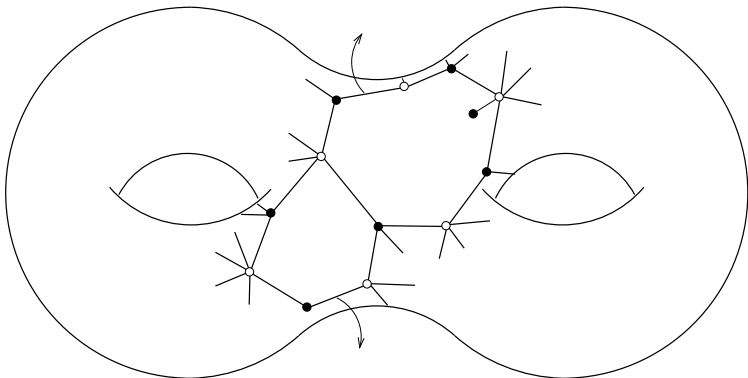

Definition of dessin d'enfant

A quick introduction to dessins d'enfants, Belyi's theorem and Galois action

Ernesto Gironde Gabino González-Diez

Dessins

PART I: From dessins to Belyi pairs

Examples

PART II: Belyi's theorem

Galois action

Action of $Gal(\overline{\mathbb{Q}})$ on triangle curves

A **dessin d'enfant**, or simply a *dessin*, is a pair (X, \mathcal{D}) where X is an oriented compact topological surface, and $\mathcal{D} \subset X$ is a finite **graph** such that:

- 1 \mathcal{D} is **connected**.
- 2 \mathcal{D} is **bicoloured**, i.e. the vertices have been given either white or black colour and vertices connected by an edge have different colours.
- 3 $X \setminus \mathcal{D}$ is the union of finitely many topological discs, which we call *faces* of \mathcal{D} .

The **genus** of (X, \mathcal{D}) is simply the genus of X .

We consider two dessins (X_1, \mathcal{D}_1) and (X_2, \mathcal{D}_2) **equivalent** when there exists an orientation-preserving homeomorphism from X_1 to X_2 whose restriction to \mathcal{D}_1 induces an isomorphism between the coloured graphs \mathcal{D}_1 and \mathcal{D}_2 .

Warning: A dessin is not an abstract graph

A quick introduction to dessins d'enfants, Belyi's theorem and Galois action

Ernesto Girondo Gabino González-Diez

Dessins

PART I: From dessins to Belyi pairs

Examples

PART II: Belyi's theorem

Galois action

Action of $Gal(\overline{\mathbb{Q}})$ on triangle curves

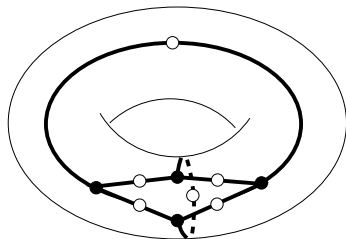
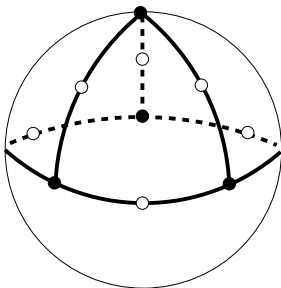

These bicoulored graphs are equal as abstract graphs but they are different as dessins: they even have different genus!

Permutation representation pair of \mathcal{D} : (σ_0, σ_1)

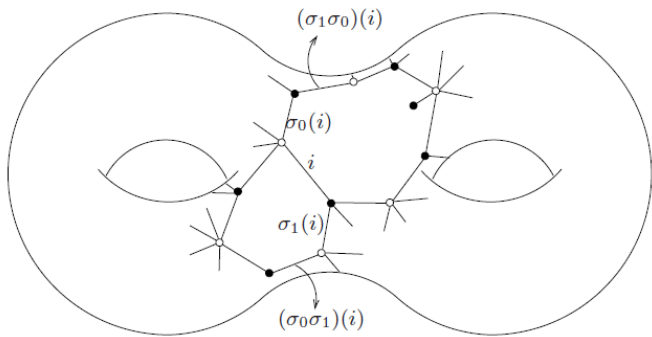

Cycles of $\sigma_0 \leftrightarrow$ white vertices of \mathcal{D} ,
(length of each cycle = degree of the corresponding vertex).

Cycles of $\sigma_1 \leftrightarrow$ black vertices, etc.

Cycles of $\sigma_1 \sigma_0 \leftrightarrow$ (1/2 of the edges of) faces of \mathcal{D}

Connectedness of $\mathcal{D} \Rightarrow \langle \sigma_0, \sigma_1 \rangle$ is a transitive subgroup.

A quick
introduction
to dessins
d'enfants,
Belyi's
theorem and
Galois action

Ernesto
Girondo
Gabino
González-Diez

Dessins

PART I: From
dessins to
Belyi pairs

Examples

PART II:
Belyi's
theorem

Galois action

Action of
 $Gal(\overline{\mathbb{Q}})$ on
triangle curves

Eg: $\sigma_0 = (1, 5, 4)(2, 6, 3)$, $\sigma_1 = (1, 2)(3, 4)(5, 6)$

$$\sigma_1\sigma_0 = (1, 6, 4, 2, 5, 3)$$

$$2 - 2g = (\#\{\text{cycles of } \sigma_0\} + \#\{\text{cycles of } \sigma_1\}) - \#\{\text{edges}\} + \#\{\text{cycles of } \sigma_1\sigma_0\} = 2 + 3 - 6 + 1 = 0$$

Of course this is nothing but the Euler–Poincaré characteristic of X corresponding to the polygonal decomposition induced by the dessin.

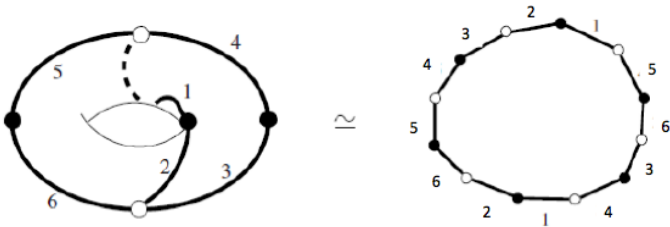

Main theorem of Grothendieck's theory of dessins

There is a correspondence between dessins d'enfants and algebraic curves defined over number fields, i.e. curves $C : F(x, y) = 0$ with $F(X, Y) \in \overline{\mathbb{Q}}[X, Y]$. E.G.:

$$\sigma_0 = (1, 7, 5, 3)$$

$$\sigma_1 = (1, 2, 3, 4, 5, 6, 7)$$

$$\tilde{\sigma}_0 = (4, 6, 8, 2)$$

$$\tilde{\sigma}_1 = (1, 2, 3, 4, 6, 7)$$

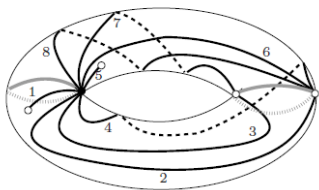
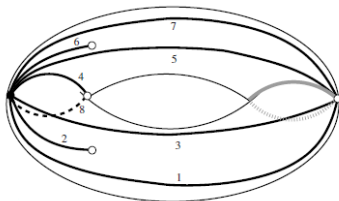

represent the algebraic curves

$$y^2 = x(x-1)(x+\sqrt{2})$$

and

$$y^2 = x(x-1)(x-\sqrt{2})$$

Sketch of the proof of the main result

A quick introduction to dessins d'enfants, Belyi's theorem and Galois action

Ernesto Gironde Gabino González-Diez

Dessins

PART I: From dessins to Belyi pairs

Examples

PART II: Belyi's theorem

Galois action

Action of $Gal(\overline{\mathbb{Q}})$ on triangle curves

PART I: To any dessin one can associate a compact Riemann surface (= an algebraic curve) together with a (Belyi) function on it.

PART II: The curves so obtained account for all algebraic curves defined over number fields.

.....

Then we will discuss the action of the absolute Galois group on dessins with special attention to the case of regular ones.

The triangle decomposition $\mathcal{T}(\mathcal{D})$ associated to \mathcal{D}

A quick
introduction
to dessins
d'enfants,
Belyi's
theorem and
Galois action

Ernesto
Girondo
Gabino
González-Díez

Dessins

PART I: From
dessins to
Belyi pairs

Examples

PART II:
Belyi's
theorem

Galois action

Action of
 $Gal(\overline{\mathbb{Q}})$ on
triangle curves

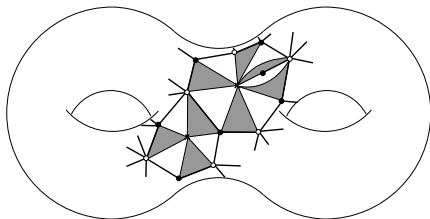
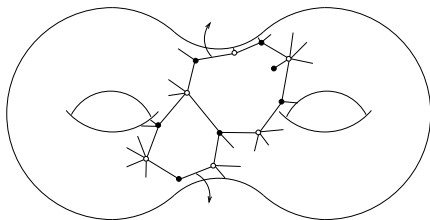

The topological covering of \mathbb{S}^2 associated to $\mathcal{T}(\mathcal{D})$

A quick introduction to dessins d'enfants, Belyi's theorem and Galois action

Ernesto Girondo Gabino González-Diez

Dessins

PART I: From dessins to Belyi pairs

Examples

PART II: Belyi's theorem

Galois action

Action of $Gal(\overline{\mathbb{Q}})$ on triangle curves

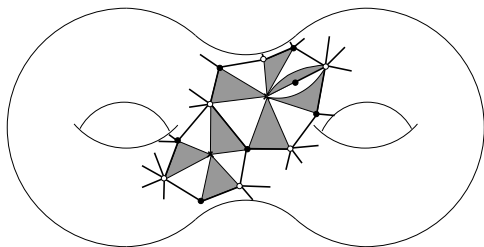

$\downarrow f_{\mathcal{D}}$

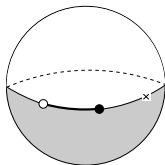

The Riemann surface structure associated to \mathcal{D}

Let $X^* = X \setminus \{o, \bullet, \times\}$.

By construction the map $f_{\mathcal{D}}^* : X^* \rightarrow \widehat{\mathbb{C}}$ is a local homeo; in fact, a topological cover of $\widehat{\mathbb{C}} \setminus \{0, 1, \infty\}$. Therefore X^* **inherits the Riemann surface structure** of $\widehat{\mathbb{C}}$; charts being defined by restriction of $f_{\mathcal{D}}^*$ to small neighborhoods.

By definition, $f_{\mathcal{D}}^* : X_{\mathcal{D}}^* \rightarrow \widehat{\mathbb{C}} \setminus \{0, 1, \infty\}$ **is a holomorphic map.**

Moreover, by standard extension arguments **this complex structure extends to a complex structure on the compact surface $X_{\mathcal{D}}$ and the function $f_{\mathcal{D}}^*$ to a meromorphic function $f_{\mathcal{D}} : X_{\mathcal{D}} \dashrightarrow \mathbb{C}$ (i.e. a holomorphic map $f_{\mathcal{D}} : X_{\mathcal{D}} \rightarrow \widehat{\mathbb{C}}$).**

Observation/Definition: $f_{\mathcal{D}} : X_{\mathcal{D}} \rightarrow \widehat{\mathbb{C}}$ is a **Belyi function** meaning that it has ≤ 3 branching values, say $0, 1, \infty$.

A quick introduction to dessins d'enfants, Belyi's theorem and Galois action

Ernesto Girono Gabino González-Díez

Dessins

PART I: From dessins to Belyi pairs

Examples

PART II: Belyi's theorem

Galois action

Action of $Gal(\overline{\mathbb{Q}})$ on triangle curves

1) Dessins $\mathcal{D} \mapsto$ Belyi pairs $(X_{\mathcal{D}}, f_{\mathcal{D}}) \equiv (C_{\mathcal{D}}, R_{\mathcal{D}})$

Due to the correspondence between meromorphic functions of compact Riemann surfaces and rational functions of algebraic curves we will sometimes denote $(X_{\mathcal{D}}, f_{\mathcal{D}})$ by $(C_{\mathcal{D}}, R_{\mathcal{D}})$ to emphasize **the algebraic nature of the Belyi pair**.

A quick introduction to dessins d'enfants, Belyi's theorem and Galois action

Ernesto Girondo Gabino González-Diez

Dessins

PART I: From dessins to Belyi pairs

Examples

PART II: Belyi's theorem

Galois action

Action of $Gal(\overline{\mathbb{Q}})$ on triangle curves

1) Dessins $\mathcal{D} \mapsto$ Belyi pairs $(X_{\mathcal{D}}, f_{\mathcal{D}}) \equiv (C_{\mathcal{D}}, R_{\mathcal{D}})$

Due to the correspondence between meromorphic functions of compact Riemann surfaces and rational functions of algebraic curves we will sometimes denote $(X_{\mathcal{D}}, f_{\mathcal{D}})$ by $(C_{\mathcal{D}}, R_{\mathcal{D}})$ to emphasize **the algebraic nature of the Belyi pair**.

This classical correspondence can be established as follows: If (h, g) is a pair of generating functions there is an irreducible polynomial $F(X, Y) \in \mathbb{C}[X, Y]$ satisfying $F(h, g) \equiv 0$ and then $X_{\mathcal{D}}$ can be identified to the curve

$$C_{\mathcal{D}} : F(x, y) = 0$$

via the map $\phi : X_{\mathcal{D}} \longrightarrow C_{\mathcal{D}}$

$$P \longmapsto (h(P), g(P))$$

Under ϕ the pair (h, g) is identified to the coordinate functions (x, y) and the Belyi function $f_{\mathcal{D}} = R(h, g)$, for some $R(X, Y) \in \mathbb{C}(X, Y)$, with the rational function $R(x, y)$ on C .

A quick introduction to dessins d'enfants, Belyi's theorem and Galois action

Ernesto Gironde Gabino González-Díez

Dessins

PART I: From dessins to Belyi pairs

Examples

PART II: Belyi's theorem

Galois action

Action of $Gal(\overline{\mathbb{Q}})$ on triangle curves

Properties of the Belyi pair $(X_{\mathcal{D}}, f_{\mathcal{D}})$

A quick
introduction
to dessins
d'enfants,
Belyi's
theorem and
Galois action

Ernesto
Girondo
Gabino
González-Diez

Dessins

PART I: From
dessins to
Belyi pairs

Examples

PART II:
Belyi's
theorem

Galois action

Action of
 $Gal(\overline{\mathbb{Q}})$ on
triangle curves

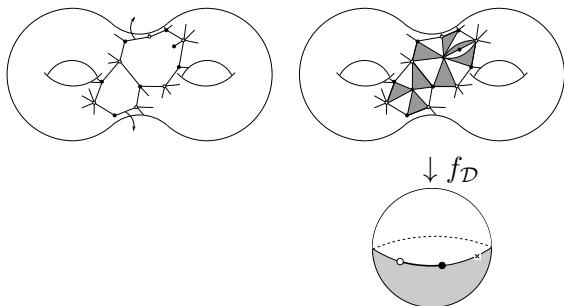

- 1 $deg(f_{\mathcal{D}}) = card(f_{\mathcal{D}}^{-1}(1/2)) = \text{number of edges of } \mathcal{D}.$
- 2 **Poles** $\leftrightarrow \{ \times \text{'s} \equiv \text{Faces} \}$; **Zeros** $\leftrightarrow \{ \circ \text{'s} \}$; **1's** $\leftrightarrow \{ \bullet \text{'s} \}$
- 3 The order of a pole \times agrees with half the number of edges of the face of which \times is a center (**suitably counted**).
- 4 The multiplicity of $f_{\mathcal{D}}$ at a vertex $v = \bullet, \circ$ of \mathcal{D} coincides with the degree of the vertex.

2) dessins $\mathcal{D}_f \leftarrow$ Belyi pairs (S, f)

Proposition

Let $f : S \rightarrow \widehat{\mathbb{C}}$ be a Belyi function and set $\mathcal{D}_f = f^{-1}([0, 1])$. Consider \mathcal{D}_f as a bicoloured graph embedded in S whose set of white (resp. black) vertices is $f^{-1}(0)$ (resp. $f^{-1}(1)$). Then

- \mathcal{D}_f is a dessin d'enfant and $\mathcal{D}_{f_{\mathcal{D}}} = \mathcal{D}$.

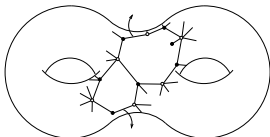

A quick
introduction
to dessins
d'enfants,
Belyi's
theorem and
Galois action

Ernesto
Girondo
Gabino
González-Díez

Dessins

PART I: From
dessins to
Belyi pairs

Examples

PART II:
Belyi's
theorem

Galois action

Action of
 $Gal(\overline{\mathbb{Q}})$ on
triangle curves

2) dessins $\mathcal{D}_f \leftarrow$ Belyi pairs (S, f)

Proposition

Let $f : S \rightarrow \widehat{\mathbb{C}}$ be a Belyi function and set $\mathcal{D}_f = f^{-1}([0, 1])$. Consider \mathcal{D}_f as a bicoloured graph embedded in S whose set of white (resp. black) vertices is $f^{-1}(0)$ (resp. $f^{-1}(1)$). Then

- \mathcal{D}_f is a dessin d'enfant and $\mathcal{D}_{f_{\mathcal{D}}} = \mathcal{D}$.

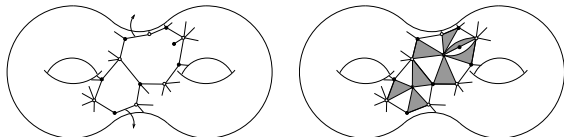

A quick
introduction
to dessins
d'enfants,
Belyi's
theorem and
Galois action

Ernesto
Girondo
Gabino
González-Díez

Dessins

PART I: From
dessins to
Belyi pairs

Examples

PART II:
Belyi's
theorem

Galois action

Action of
 $Gal(\overline{\mathbb{Q}})$ on
triangle curves

2) dessins $\mathcal{D}_f \leftarrow$ Belyi pairs (S, f)

Proposition

Let $f : S \rightarrow \widehat{\mathbb{C}}$ be a Belyi function and set $\mathcal{D}_f = f^{-1}([0, 1])$. Consider \mathcal{D}_f as a bicoloured graph embedded in S whose set of white (resp. black) vertices is $f^{-1}(0)$ (resp. $f^{-1}(1)$). Then

- \mathcal{D}_f is a dessin d'enfant and $\mathcal{D}_{f_{\mathcal{D}}} = \mathcal{D}$.

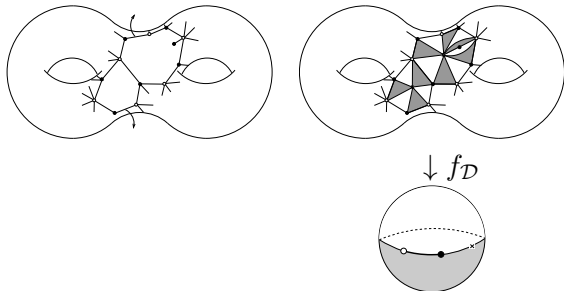

A quick
introduction
to dessins
d'enfants,
Belyi's
theorem and
Galois action

Ernesto
Girondo
Gabino
González-Díez

Dessins

PART I: From
dessins to
Belyi pairs

Examples

PART II:
Belyi's
theorem

Galois action

Action of
 $Gal(\overline{\mathbb{Q}})$ on
triangle curves

Dessins \longleftrightarrow Belyi pairs

A quick introduction to dessins d'enfants, Belyi's theorem and Galois action

Ernesto Gironde Gabino González-Diez

Dessins

PART I: From dessins to Belyi pairs

Examples

PART II: Belyi's theorem

Galois action

Action of $Gal(\overline{\mathbb{Q}})$ on triangle curves

Theorem

The correspondences

$\{\text{Equiv. classes of dessins}\} \longrightarrow \{\text{Equiv. classes of Belyi pairs}\}$

$$(X, \mathcal{D}) \longmapsto (X_{\mathcal{D}}, f_{\mathcal{D}}) = (C_{\mathcal{D}}, R_{\mathcal{D}})$$

$$(S, \mathcal{D}_f) \longleftarrow (S, f)$$

are mutually inverse.

Equivalent ways to describe dessins

- 1) **Dessins** \mathcal{D} of degree n .
- 2) **Belyi pairs** (C, R) with $\deg(R) = n$.
- 3) **Pairs of permutations** (σ_0, σ_1) generating a transitive subgroup of S_n .
- 4) **Finite index subgroups** of $\Gamma(2) = \Delta(\infty, \infty, \infty)$.
- 5) **Finite index subgroups** of $\Delta(l, m, d)$

The link between 4) (or 5)) and 3) is established as follows:

Suppose that l, m, d are the orders of $\sigma_0, \sigma_1, \sigma_0\sigma_1$ and consider the homomorphism

$$\rho : \Delta(l, m, d) \rightarrow S_n$$

determined by $x, y, z \rightarrow \sigma_0, \sigma_1, (\sigma_0\sigma_1)^{-1}$
then, the subgroup of $\Delta(l, m, d)$ in question is the preimage of the inertia subgroup of $\langle \sigma_0, \sigma_1 \rangle$.

A quick
introduction
to dessins
d'enfants,
Belyi's
theorem and
Galois action

Ernesto
Girondo
Gabino
González-Díez

Dessins

PART I: From
dessins to
Belyi pairs

Examples

PART II:
Belyi's
theorem

Galois action

Action of
 $Gal(\overline{\mathbb{Q}})$ on
triangle curves

genus of \mathcal{D} equals 0 $\Rightarrow (C_{\mathcal{D}}, f_{\mathcal{D}}) \equiv (\widehat{\mathbb{C}}, R(z))$

$$\sigma_0 = (1, 2, 3, 4)$$

$$\sigma_1 = (1)(2)(3)(4)$$

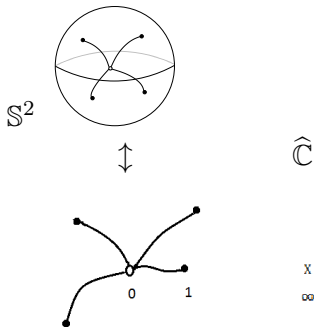

- 1) \mathcal{D} has only one face $\Rightarrow R \equiv f_{\mathcal{D}}$ is a polynomial.
- 2) \mathcal{D} has 4 edges $\Rightarrow \deg(R) = 4$
- 3) \mathcal{D} has a white vertex of degree 4 at $z = 0 \Rightarrow R(z) = cz^4$
- 4) 1 is a black vertex $\Rightarrow R(1) = 1 \Rightarrow \boxed{R(z) = z^4}$



The modular function $j(\lambda) = \frac{4}{27} \frac{(1-\lambda+\lambda^2)^3}{\lambda^2(\lambda-1)^2}$

It is easy to check that this is a Belyi function and that its corresponding dessin is

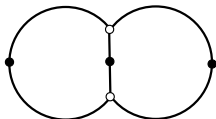

- The 3 faces (of degree 4) correspond to the 3 poles $0, 1, \infty$ (of degree $4/2=2$).
- The 2 white vertices (of degree 3) stand for the 2 roots of $(1 - \lambda + \lambda^2)^3 = 0$ (of degree 3).
- The 3 black vertices (of order 2) correspond to the remaining three branch points (of degree 2) one encounters by computing the derivative, namely

$$j'(\lambda) = \frac{(\lambda^2 - \lambda + 1)^2}{\lambda^3(\lambda - 1)^3} (2\lambda - 1)(\lambda^2 - \lambda - 2) = 0$$

A genus one example

A quick introduction to dessins d'enfants, Belyi's theorem and Galois action

Ernesto Girondo Gabino González-Diez

Dessins

PART I: From dessins to Belyi pairs

Examples

PART II: Belyi's theorem

Galois action

Action of $Gal(\overline{\mathbb{Q}})$ on triangle curves

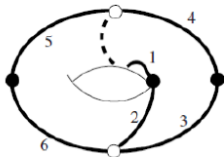

\simeq

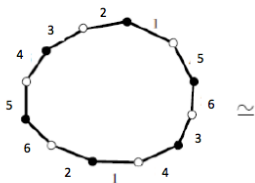

\simeq

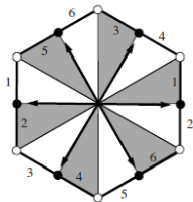

\simeq

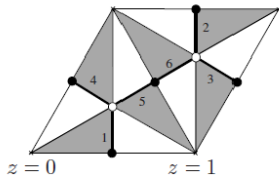

A genus one example

A quick introduction to dessins d'enfants, Belyi's theorem and Galois action

Ernesto Girondo Gabino González-Diez

Dessins

PART I: From dessins to Belyi pairs

Examples

PART II: Belyi's theorem

Galois action

Action of $Gal(\overline{\mathbb{Q}})$ on triangle curves

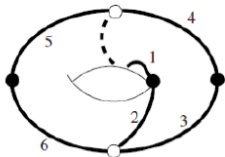

\cong

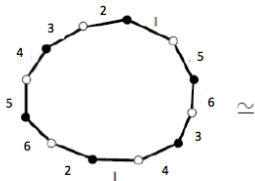

\cong

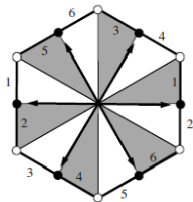

\cong

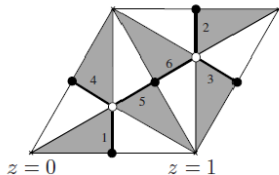

From here one can see that the corresponding Belyi pair is

$$(\mathbb{CZ} \oplus \mathbb{Z}e^{2\pi i/3}, \wp^3) \cong (y^2 = x^3 - 1, x^3)$$

(\wp =Weierstrass function)

Belyi's theorem

We now deal with the second part. We wanted to show that there is a correspondence

$$\{\text{Dessins}\} \leftrightarrow \{\text{Curves defined over } \overline{\mathbb{Q}} \text{ (plus a Belyi function)}\}$$

We already established the correspondence

$$\{\text{Equiv. classes of dessins}\} \leftrightarrow \{\text{Equiv. classes of Belyi pairs}\}$$

so it remains to show that Belyi curves are defined over $\overline{\mathbb{Q}}$.

Theorem (Belyi, 1979)

Let S be a compact Riemann surface. The following statements are equivalent:

- (a) *S is defined over $\overline{\mathbb{Q}}$ (or, equivalently, over a number field).*
- (b) *S admits a morphism $f : S \rightarrow \mathbb{P}^1$ with at most three branching values, i.e. a Belyi function.*

A quick introduction to dessins d'enfants, Belyi's theorem and Galois action

Ernesto Gironde Gabino González-Diez

Dessins

PART I: From dessins to Belyi pairs

Examples

PART II: Belyi's theorem

Galois action

Action of $\text{Gal}(\overline{\mathbb{Q}})$ on triangle curves

(Proof of \Rightarrow)
$$P(z) = \frac{(m+n)^{m+n}}{m^m n^n} z^m (1-z)^n$$

$$\left\{ y^2 = x(x-1) \left(x - \sqrt{\frac{m+n}{m}} \right) \right\} \cup \{\infty\}$$

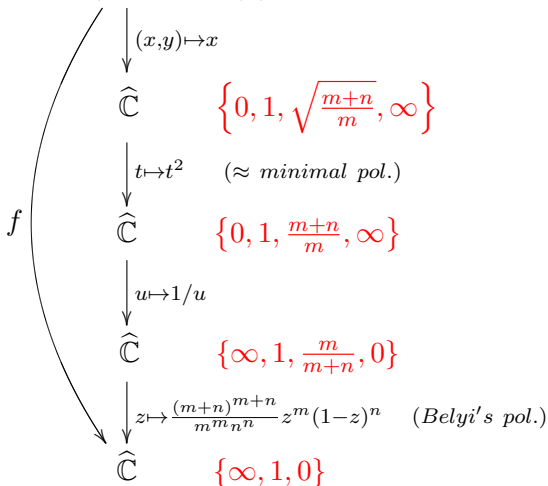

A quick introduction to dessins d'enfants, Belyi's theorem and Galois action

Ernesto Gironde Gabino González-Diez

Dessins

PART I: From dessins to Belyi pairs

Examples

PART II: Belyi's theorem

Galois action

Action of $Gal(\overline{\mathbb{Q}})$ on triangle curves

Proof of \Leftarrow)

A complex number α lies in $\overline{\mathbb{Q}} \Leftrightarrow$ the set of complex numbers

$$G_{\mathbb{C}}(\alpha) = \{\alpha^{\sigma} := \sigma(\alpha) \text{ such that } \sigma \in G_{\mathbb{C}} := \text{Gal}(\mathbb{C})\}$$

is finite.

Examples:

- $G_{\mathbb{C}}(\alpha) = \{\alpha\} \Leftrightarrow \alpha \in \mathbb{Q}$
- $G_{\mathbb{C}}(\sqrt{2}) = \{\sqrt{2}, -\sqrt{2}\}$
- $G_{\mathbb{C}}(\pi) = \{\text{transcendental numbers}\}$

If $C : F(x, y) = \sum a_{ij} x^i y^j = 0$ we define

$$C^{\sigma} : F^{\sigma}(x, y) = \sum a_{ij}^{\sigma} x^i y^j = 0, \quad G_{\mathbb{C}}(C) = \{C^{\sigma} : \sigma \in G_{\mathbb{C}}\}$$

Then, again: C is defined over $\overline{\mathbb{Q}} \Leftrightarrow G_{\mathbb{C}}(C)/\text{equiv.}$ is finite.

The analogous statement holds for coverings (C, R) of \mathbb{P}^1 .

Proof of \Leftarrow)

Consider the following commutative diagram

$$\begin{array}{ccc} C & \xrightarrow{\sigma} & C^\sigma \\ \downarrow R & & \downarrow R^\sigma \\ \mathbb{P}^1 & \xrightarrow{\sigma} & \mathbb{P}^1 \end{array} \quad \left(\sigma(a, b) = (a^\sigma, b^\sigma) \right)$$

(i.e. $R(a, b)^\sigma = R^\sigma(a^\sigma, b^\sigma)$)

It shows that σ sends Belyi pairs of **degree** n to Belyi pairs of **same degree** n , hence there is an action of $G_{\mathbb{C}}$ on dessins:

$$\begin{array}{ccc} \mathcal{D} & \dashrightarrow & \mathcal{D}^\sigma \\ \downarrow & & \uparrow \\ (C_{\mathcal{D}}, R_{\mathcal{D}}) & \xrightarrow{\sigma} & (C_{\mathcal{D}}^\sigma, R_{\mathcal{D}}^\sigma) \end{array}$$

Because the degree and the branching is preserved, **the set**

$$G_{\mathbb{C}}(C, R) = \{(C^\sigma, R^\sigma) : \sigma \in G_{\mathbb{C}}\} \leftrightarrow G_{\mathbb{C}}(\mathcal{D}) = \{\mathcal{D}^\sigma : \sigma \in G_{\mathbb{C}}\}$$

is finite $\Rightarrow C$ and R can be defined over a number field. 

Grothendieck's action of $\text{Gal}(\overline{\mathbb{Q}})$ on dessins

Once we know that Belyi pairs are defined over $\overline{\mathbb{Q}}$ it makes sense to “restrict” the action of $\text{Gal}(\mathbb{C})$ on dessins

$$\begin{array}{ccc} \mathcal{D} & \dashrightarrow & \mathcal{D}^\sigma \\ \downarrow & & \uparrow \\ (C_{\mathcal{D}}, R_{\mathcal{D}}) & \xrightarrow{\sigma} & (C_{\mathcal{D}}^\sigma, R_{\mathcal{D}}^\sigma) \end{array}$$

to an action of $\text{Gal}(\overline{\mathbb{Q}})$ in the hope this action of the absolute Galois group on combinatorial objects might help to understand the nature of the group.

Let us look at a couple of examples

A quick introduction to dessins d'enfants, Belyi's theorem and Galois action

Ernesto Gironde Gabino González-Diez

Dessins

PART I: From dessins to Belyi pairs

Examples

PART II: Belyi's theorem

Galois action

Action of $\text{Gal}(\overline{\mathbb{Q}})$ on triangle curves

$\text{Gal}(\overline{\mathbb{Q}})$ -orbits of female and male symbols

A quick introduction to dessins d'enfants, Belyi's theorem and Galois action

Ernesto Girondo Gabino González-Diez

Dessins

PART I: From dessins to Belyi pairs

Examples

PART II: Belyi's theorem

Galois action

Action of $\text{Gal}(\overline{\mathbb{Q}})$ on triangle curves

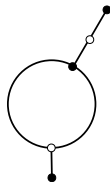
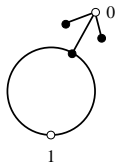
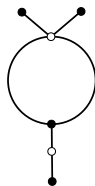
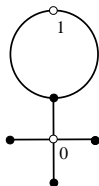

$$f(z) = \frac{z^4(z-1)^2}{(z-b)} \quad \text{where} \quad 36b^2 - 44b + 9 = 0$$

$$m(z) = \frac{z^3(z-1)^2}{(z-b)} \quad \text{where} \quad 25b^2 - 28b + 4 = 0$$

$Gal(\overline{\mathbb{Q}})$ -action on the dessin corresponding to $(y^2 = x(x-1)(x+\sqrt{2}), f(x,y) = \frac{-4(x^2-1)}{(x^2-2)^2})$

It can be seen that the following two dessins form a complete orbit for the action of $Gal(\overline{\mathbb{Q}})$.

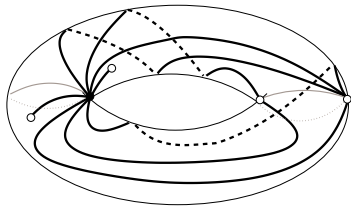
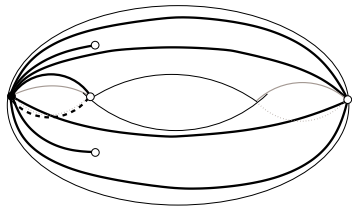

$$(y^2 = x(x-1)(x+\sqrt{2}), f)$$

$$(y^2 = x(x-1)(x-\sqrt{2}), f)$$

They are conjugate by any σ satisfying the property

$$\sigma(\sqrt{2}) = -\sqrt{2}.$$

Dessin of $f : \{y^2 = x(x-1)(x-\sqrt{2})\} \rightarrow \widehat{\mathbb{C}}$

A quick introduction to dessins d'enfants, Belyi's theorem and Galois action

Ernesto Girondo Gabino González-Diez

Dessins

PART I: From dessins to Belyi pairs

Examples

PART II: Belyi's theorem

Galois action

Action of $Gal(\overline{\mathbb{Q}})$ on triangle curves

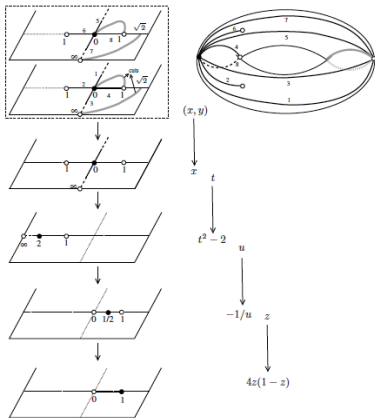

$$f(x, y) = \frac{-4(x^2-1)}{(x^2-2)^2}$$

Regular dessins

\mathcal{D} is said to be **regular** if $G = \text{Aut}(\mathcal{D})$ acts transitively on its edges so that $(X_{\mathcal{D}}, f_{\mathcal{D}})$ is a Galois cover with covering group G .

$$\begin{array}{ccc} X_{\mathcal{D}} & & \\ \pi \downarrow & \searrow f_{\mathcal{D}} & \\ X_{\mathcal{D}}/\text{Aut}(\mathcal{D}) & \xrightarrow{\sim} & \mathbb{P}^1 \end{array}$$

A quick introduction to dessins d'enfants, Belyi's theorem and Galois action

Ernesto Girondo Gabino González-Diez

Dessins

PART I: From dessins to Belyi pairs

Examples

PART II: Belyi's theorem

Galois action

Action of $\text{Gal}(\overline{\mathbb{Q}})$ on triangle curves

Regular dessins

\mathcal{D} is said to be **regular** if $G = \text{Aut}(\mathcal{D})$ acts transitively on its edges so that $(X_{\mathcal{D}}, f_{\mathcal{D}})$ is a Galois cover with covering group G .

$$\begin{array}{ccc} X_{\mathcal{D}} & & \\ \pi \downarrow & \searrow f_{\mathcal{D}} & \\ X_{\mathcal{D}}/\text{Aut}(\mathcal{D}) & \xrightarrow{\sim} & \mathbb{P}^1 \end{array}$$

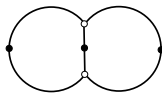

We have already seen an example:

$$\begin{array}{ccc} \widehat{\mathbb{C}} & & \\ \pi \downarrow & \searrow j(\lambda) = \frac{(1-\lambda+\lambda^2)^3}{\lambda^2(\lambda-1)^2} \quad (\Rightarrow \text{Gal}(\overline{\mathbb{Q}}) \text{ acts trivially}) & \\ \widehat{\mathbb{C}}/G & \xrightarrow{\sim} & \mathbb{P}^1 \end{array}$$

$(G = \langle z \rightarrow 1-z, z \rightarrow 1/(1-z) \rangle \cong S_3)$

A quick introduction to dessins d'enfants, Belyi's theorem and Galois action

Ernesto Girondo Gabino González-Diez

Dessins

PART I: From dessins to Belyi pairs

Examples

PART II: Belyi's theorem

Galois action

Action of $\text{Gal}(\overline{\mathbb{Q}})$ on triangle curves

Faithfulness of the action of $Gal(\overline{\mathbb{Q}})$

A key point in Grothendieck's theory of dessins is that the action of $Gal(\overline{\mathbb{Q}})$ on them, or equivalently on Belyi pairs (C, f) , is faithful.

A quick
introduction
to dessins
d'enfants,
Belyi's
theorem and
Galois action

Ernesto
Girondo
Gabino
González-Diez

Dessins

PART I: From
dessins to
Belyi pairs

Examples

PART II:
Belyi's
theorem

Galois action

Action of
 $Gal(\overline{\mathbb{Q}})$ on
triangle curves

Faithfulness of the action of $Gal(\overline{\mathbb{Q}})$

A key point in Grothendieck's theory of dessins is that the action of $Gal(\overline{\mathbb{Q}})$ on them, or equivalently on Belyi pairs (C, f) , is faithful.

In fact, except for the case $g = 0$, the action is already faithful on the set of Belyi curves C of any given genus (disregarding the Belyi function).

For instance if $\sigma \in Gal(\overline{\mathbb{Q}})$ is non-trivial and $j(\lambda)^\sigma \neq j(\lambda)$ then the elliptic curves

$$C : y^2 = (x - 1)(x - 2)(x - \lambda) \quad \text{and}$$

$$C^\sigma : y^2 = (x - 1)(x - 2)(x - \lambda^\sigma)$$

are non-isomorphic to each other.

A quick
introduction
to dessins
d'enfants,
Belyi's
theorem and
Galois action

Ernesto
Girondo
Gabino
González-Diez

Dessins

PART I: From
dessins to
Belyi pairs

Examples

PART II:
Belyi's
theorem

Galois action

Action of
 $Gal(\overline{\mathbb{Q}})$ on
triangle curves

Triangle curves

Q. 1: Does $\text{Gal}(\overline{\mathbb{Q}})$ act faithfully on regular dessins (C, f) ?

Curves arising in this way are called **triangle (or quasiplatonic) curves** i.e. C is a triangle curve if $C/\text{Aut}(C) \cong \mathbb{P}^1$ and the projection $f : C \rightarrow C/\text{Aut}(C) \cong \mathbb{P}^1$ ramifies over 3 values.

Q. 1': Is the action of $\text{Gal}(\overline{\mathbb{Q}})$ faithful on triangle curves?

There are only finitely many triangle curves in each genus

List of triangle curves in low genus

- **Genus 2:** $y^2 = x^6 - x$, $y^2 = x^6 - 1$, $y^2 = x^5 - x$
- **Genus 3:** $y^2 = x^8 - x$, $y^2 = x^7 - x$, $y^2 = x^8 - 1$,
 $y^2 = x^8 - 14x^4 + 1$, $y^3 = x(1 - x^3)$,
 $y^4 = 1 - x^3$, $y^4 = 1 - x^4$, $y^7 = x(1 - x)^2$
- **Genus 4:** 11 curves **all of them again defined over \mathbb{Q} .**

$Gal(\overline{\mathbb{Q}})$ acts faithfully on triangle curves

A quick introduction to dessins d'enfants, Belyi's theorem and Galois action

Ernesto Girondo Gabino González-Díez

Dessins

PART I: From dessins to Belyi pairs

Examples

PART II: Belyi's theorem

Galois action

Action of $Gal(\overline{\mathbb{Q}})$ on triangle curves

In all previous examples of triangle curves the action of $Gal(\overline{\mathbb{Q}})$ is trivial. However:

Theorem (-, A. Jaikin-Zapirain)

$Gal(\overline{\mathbb{Q}})$ acts faithfully on triangle curves.

In fact on the subset of triangle curves which are Galois covers of a given one, e.g. Fermat's or Klein's curve, or any of the previous list.....

A quick
introduction
to dessins
d'enfants,
Belyi's
theorem and
Galois action

Ernesto
Girondo
Gabino
González-Diez

Dessins

PART I: From
dessins to
Belyi pairs

Examples

PART II:
Belyi's
theorem

Galois action

Action of
 $Gal(\overline{\mathbb{Q}})$ on
triangle curves

THANK YOU